

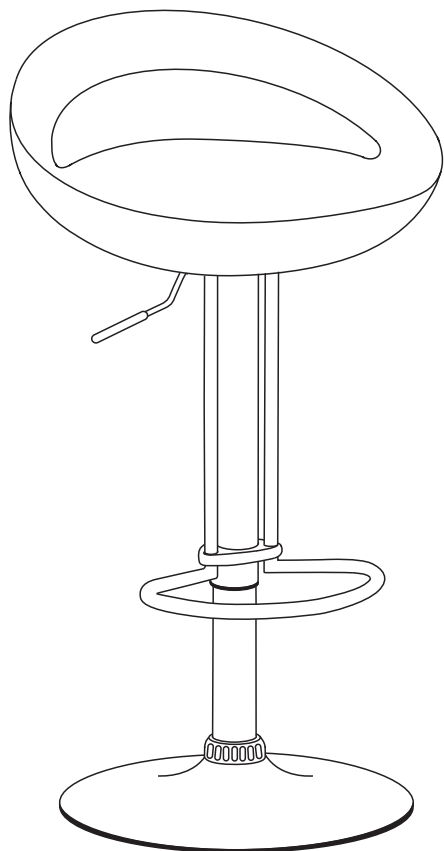

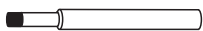



# ASSEMBLY INSTRUCTION

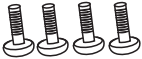

NO	PARTS	QTY
A		1
B		1
C		1
D		1
E		4
F		1
G		1

## NOTICE!

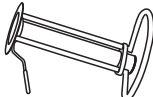

Pls remove the black protective cap from gas lift before assembling.

